

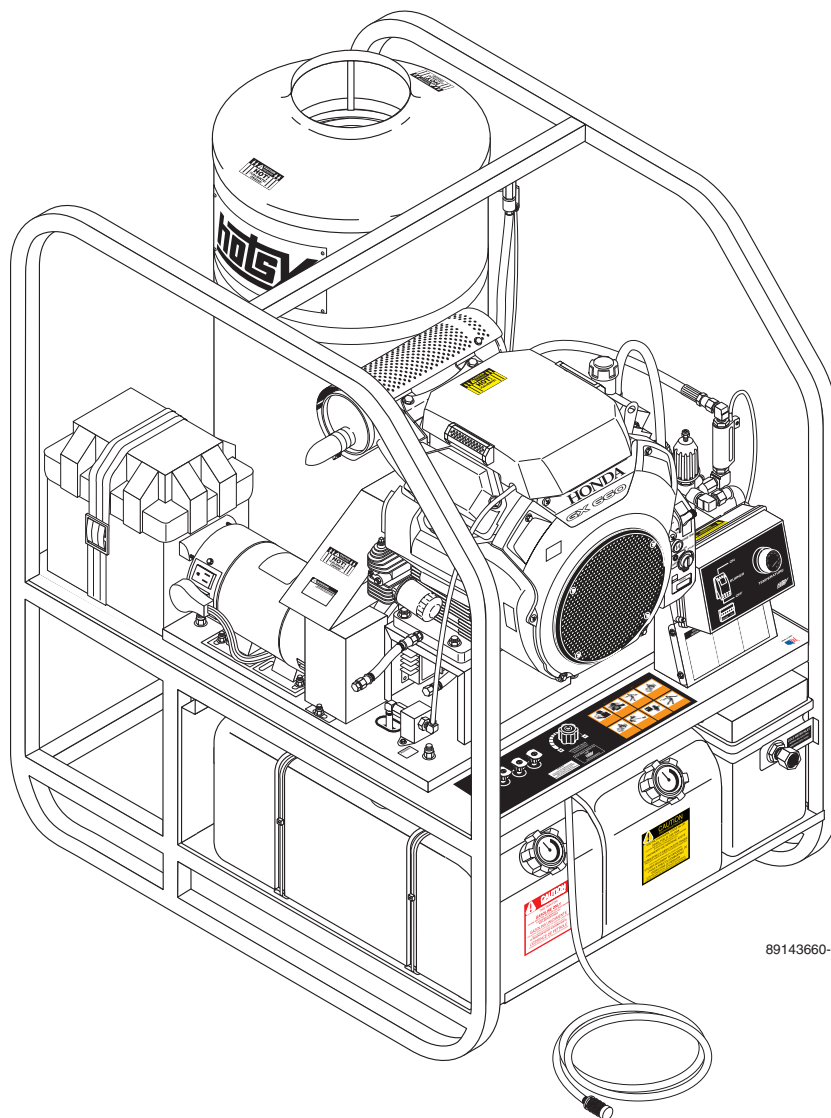

# 1200 SERIES

# OPERATOR'S MANUAL

- 
- |           |           |           |           |           |
|-----------|-----------|-----------|-----------|-----------|
| ■ 1260SS  | ■ 1260SSG | ■ 1270SS  | ■ 1270SSG | ■ 1280SS  |
| ■ 1280SSG | ■ 1285SS  | ■ 1285SSG | ■ 1290SS  | ■ 1290SSG |
- 



---

FOR TECHNICAL ASSISTANCE OR THE HOTSY DEALER NEAREST YOU,  
CONSULT OUR WEB PAGE AT [WWW.HOTSY.COM](http://WWW.HOTSY.COM)

8.914-366.0

---

## 1260SS SPECIFICATIONS

- Pump Volume At Pump Head: 4.3 GPM/258 GPH
- Pump Pressure At Pump Head: 3000 PSI
- Burner Type: Fuel Oil Fired, 385,000 BTU/Hr.
- Burner Fuel Pressure: 150 PSI
- Burner Exhaust Stack: 10"
- Machine Power: Briggs Vanguard
- Machine Weight: 690 Lbs.
- Shipping Weight: 780 Lbs.
- Machine Dimensions:  
Length = 45", Width = 33", Height = 52"

---

## 1260SSG SPECIFICATIONS

- Pump Volume At Pump Head: 4.3 GPM/258 GPH
- Pump Pressure At Pump Head: 3000 PSI
- Burner Type: Fuel Oil Fired, 398,000 BTU/Hr.
- Burner Fuel Pressure: 160 PSI
- Burner Exhaust Stack: 10"
- Machine Power: Briggs Vanguard
- Machine Weight: 720 Lbs.
- Shipping Weight: 810 Lbs.
- Machine Dimensions:  
Length = 45", Width = 33", Height = 52"

---

## 1270SS SPECIFICATIONS

- Pump Volume At Pump Head: 4.5 GPM/270 GPH
- Pump Pressure At Pump Head: 4000 PSI
- Burner Type: Fuel Oil Fired, 385,000 BTU/Hr.
- Burner Fuel Pressure: 150 PSI
- Burner Exhaust Stack: 10"
- Machine Power: Honda GX630
- Machine Weight: 750 Lbs.
- Shipping Weight: 840 Lbs.
- Machine Dimensions:  
Length = 45", Width = 33", Height = 52"

---

## 1270SSG SPECIFICATIONS

- Pump Volume At Pump Head: 4.5 GPM/270 GPH
- Pump Pressure At Pump Head: 4000 PSI
- Burner Type: Fuel Oil Fired, 398,000 BTU/Hr.
- Burner Fuel Pressure: 160 PSI
- Burner Exhaust Stack: 10"
- Machine Power: Honda GX630
- Machine Weight: 780 Lbs.
- Shipping Weight: 870 Lbs.
- Machine Dimensions:  
Length = 45", Width = 33", Height = 52"

---

## 1280SS SPECIFICATIONS

- Pump Volume At Pump Head: 5.2 GPM/306 GPH
- Pump Pressure At Pump Head: 3500 PSI
- Burner Type: Fuel Oil Fired, 385,000 BTU/Hr.
- Burner Fuel Pressure: 150 PSI
- Burner Exhaust Stack: 10"
- Machine Power: Honda GX630
- Machine Weight: 750 Lbs.
- Shipping Weight: 840 Lbs.
- Machine Dimensions:  
Length = 45", Width = 33", Height = 52"

---

## 1280SSG SPECIFICATIONS

- Pump Volume At Pump Head: 5.2 GPM/306 GPH
- Pump Pressure At Pump Head: 3500 PSI
- Burner Type: Fuel Oil Fired, 398,000 BTU/Hr.
- Burner Fuel Pressure: 160 PSI
- Burner Exhaust Stack: 10"
- Machine Power: Honda GX630
- Machine Weight: 780 Lbs.
- Shipping Weight: 870 Lbs.
- Machine Dimensions:  
Length = 45", Width = 33", Height = 52"

---

## 1285SS SPECIFICATIONS

- Pump Volume At Pump Head: 5.2 GPM/306 GPH
- Pump Pressure At Pump Head: 3500 PSI
- Burner Type: Fuel Oil Fired, 385,000 BTU/Hr.
- Burner Fuel Pressure: 150 PSI
- Burner Exhaust Stack: 10"
- Machine Power: Briggs Vanguard
- Machine Weight: 750 Lbs.
- Shipping Weight: 840 Lbs.
- Machine Dimensions:  
Length = 45", Width = 33", Height = 52"

---

## 1290SS SPECIFICATIONS

- Pump Volume At Pump Head: 5.6 GPM/336 GPH
- Pump Pressure At Pump Head: 3000 PSI
- Burner Type: Fuel Oil Fired, 385,000 BTU/Hr.
- Burner Fuel Pressure: 150 PSI
- Burner Exhaust Stack: 10"
- Machine Power: Honda GX630
- Machine Weight: 750 Lbs.
- Shipping Weight: 840 Lbs.
- Machine Dimensions:  
Length = 45", Width = 33", Height = 52"

---

## 1285SSG SPECIFICATIONS

- Pump Volume At Pump Head: 5.2 GPM/306 GPH
- Pump Pressure At Pump Head: 3500 PSI
- Burner Type: Fuel Oil Fired, 398,000 BTU/Hr.
- Burner Fuel Pressure: 160 PSI
- Burner Exhaust Stack: 10"
- Machine Power: Briggs Vanguard
- Machine Weight: 780 Lbs.
- Shipping Weight: 870 Lbs.
- Machine Dimensions:  
Length = 45", Width = 33", Height = 52"

---

## 1290SSG SPECIFICATIONS

- Pump Volume At Pump Head: 5.6 GPM/336 GPH
- Pump Pressure At Pump Head: 3000 PSI
- Burner Type: Fuel Oil Fired, 398,000 BTU/Hr.
- Burner Fuel Pressure: 160 PSI
- Burner Exhaust Stack: 10"
- Machine Power: Honda GX630
- Machine Weight: 780 Lbs.
- Shipping Weight: 870 Lbs.
- Machine Dimensions:  
Length = 45", Width = 33", Height = 52"

# CONTENTS

---

Introduction & Important Safety Information	6-8
Component Identification	9
Assembly Instructions	10
Installation	11-12
Operation Instructions	13-14
Detergents & General Washing Techniques	15
Shut Down Instructions & Storage	16
Maintenance	17
Troubleshooting Guide	18-19
Warranty	

# INTRODUCTION & IMPORTANT SAFETY INFORMATION

Thank you for purchasing this Pressure Washer. We reserve the right to make changes at any time without incurring any obligation.

## Owner/User Responsibility:

The owner and/or user must have an understanding of the manufacturer's operating instructions and warnings before using this pressure washer. Warning information should be emphasized and understood. If the operator is not fluent in English, the manufacturer's instructions and warnings shall be read to and discussed with the operator in the operator's native language by the purchaser/owner, making sure that the operator comprehends its contents.

Owner and/or user must study and maintain for future reference the manufacturers' instructions.

The operator must know how to stop the machine quickly and understand the operation of all controls. Never permit anyone to operate the engine without proper instructions.

**This manual should be considered a permanent part of the machine and should remain with it if machine is resold.**

**When ordering parts, please specify model and serial number. Use only identical replacement parts.**

**This machine is to be used only by trained operators.**

## IMPORTANT SAFETY INFORMATION



**WARNING**

READ OPERATOR'S MANUAL THOROUGHLY PRIOR TO USE.

**WARNING: To reduce the risk of injury, read operating instructions carefully before using.**

1. Read owner's manual thoroughly. Failure to follow instructions could cause malfunction of the machine and result in death, serious bodily injury and/or property damage.

2. Know how to stop the machine and bleed pressure quickly. Be thoroughly familiar with the controls.
3. Stay alert — watch what you are doing.



**WARNING**

KEEP WATER SPRAY AWAY FROM ELECTRICAL WIRING.

**WARNING: Keep wand, hose, and water spray away from electric wiring or fatal electric shock may result.**

4. All installations must comply with local codes. Contact your electrician, plumber, utility company or the selling distributor for specific details.



**WARNING**

EAR PROTECTION MUST BE WORN

**WARNING: This machine exceeds 85 db appropriate ear protection must be worn.**



**WARNING**

USE PROTECTIVE EYE WEAR AND CLOTHING WHEN OPERATING THIS EQUIPMENT.

**WARNING: High pressure spray can cause paint chips or other particles to become airborne and fly at high speeds. To avoid personal injury, eye, hand and foot safety devices must be worn.**

5. Eye, hand, and foot protection must be worn when using this equipment.

6. Keep operating area clear of all persons.



**WARNING**

RISK OF EXPLOSION: OPERATE ONLY WHERE OPEN FLAME OR TORCH IS PERMITTED

**WARNING: Flammable liquids can create fumes which can ignite, causing property damage or severe injury.**

**WARNING: Risk of explosion — Operate only where open flame or torch is permitted.**



**WARNING**

RISK OF FIRE. DO NOT ADD FUEL WHEN OPERATING MACHINE.

**WARNING: Risk of fire — Do not add fuel when the product is operating or still hot.**

**WARNING: Do not use gasoline crankcase draining or oil containing gasoline, solvents or alcohol. Doing so will result in fire and/or explosion.**

**WARNING: Risk of fire — Do not Spray flammable liquids.**

7. Allow engine to cool for 1-2 minutes before refueling. If any fuel is spilled, make sure the area is dry before testing the spark plug or starting the engine. (Fire and/or explosion may occur if this is not done.)

Gasoline engines on mobile or portable equipment shall be refueled:

- a. outdoors;
- b. with the engine on the equipment stopped;
- c. with no source of ignition within 10 feet of the dispensing point; and
- d. with an allowance made for expansion of the fuel should the equipment be exposed to a higher ambient temperature.

# IMPORTANT SAFETY INFORMATION

In an overfilling situation, additional precautions are necessary to ensure that the situation is handled in a safe manner.

**WARNING: Risk of injury. Disconnect battery ground terminal before servicing.**

8. When in use, do not place machine near flammable objects as the engine is hot.
9. Oil burning appliances shall be installed only in locations where combustible dusts and flammable gases or vapors are not present. Do not store or use gasoline near this machine.
10. Use No. 1 or No. 2 heating oil (ASTM D306) only. **NEVER** use gasoline in your fuel oil tank. Gasoline is more combustible than fuel oil and could result in a serious explosion. **NEVER** use crankcase or waste oil in your burner. Fuel unit malfunction could result from contamination.
11. Do not confuse gasoline and fuel oil tanks. Keep proper fuel in proper tank.



**WARNING: Risk of injury. Hot surfaces can cause burns. Use only designated gripping areas of spray gun and wand. Do not place hands or feet on non-insulated areas of the pressure washer.**

12. Transport/Repair with fuel tank EMPTY or with fuel shut-off valve OFF.



**CAUTION: Hot discharge fluid. Do not touch or direct discharge stream at persons.**

**WARNING: This machine produces hot water and must have insulated components attached to protect the operator.**

13. To reduce the risk of injury, close supervision is necessary when a machine is used near children. Do not allow children to operate the pressure washer. **This machine must be attended during operation.**



**WARNING: Grip cleaning wand securely with both hands before starting. Failure to do this could result in injury from a whipping wand.**

14. Never make adjustments on machine while in operation.

15. Be certain all quick coupler fittings are secured before using pressure washer.



**WARNING: High pressure developed by these machines will cause personal injury or equipment damage. Keep clear of nozzle. Use caution when operating. Do not direct discharge stream at people, or severe injury or death will result.**



**WARNING: Protect machine from freezing.**

16. To keep machine in best operating conditions, it is important you protect machine from freezing. Failure to protect machine from freezing could cause malfunction of the machine and result in death,

serious bodily injury, and/or property damage. Follow storage instructions specified in this manual.

17. Inlet water must be clean fresh water and no hotter than 90°F.



**WARNING: Risk of asphyxiation. Use this product only in a well ventilated area.**

18. Avoid installing machines in small areas or near exhaust fans. Adequate oxygen is needed for combustion or dangerous carbon monoxide will result.

19. Manufacturer will not be liable for any changes made to our standard machines or any components not purchased from us.

20. The best insurance against an accident is precaution and knowledge of the machine.



**WARNING: Be extremely careful when using a ladder, scaffolding or any other relatively unstable location. The cleaning area should have adequate slopes and drainage to reduce the possibility of a fall due to slippery surfaces.**

## IMPORTANT SAFETY INFORMATION

21. Do not allow acids, caustic or abrasive fluids to pass through the pump.
22. Never run pump dry or leave spray gun closed longer than 1-2 minutes.
23. Machines with shut-off spray gun should not be operated with the spray gun in the off position for extensive periods of time as this may cause damage to the pump.
24. Protect discharge hose from vehicle traffic and sharp objects. Inspect condition of high pressure hose before using or bodily injury may result.
25. Before disconnecting discharge hose from water outlet, turn burner off and open spray gun to allow water to cool below 100° before stopping the machine. Then open the spray gun to relieve pressure. Failure to properly cool down or maintain the heating coil may result in a steam explosion.
26. Do not overreach or stand on unstable support. Keep good footing and balance at all times.
27. Do not operate this machine when fatigued or under the influence of alcohol, prescription medications, or drugs.
28. In oil burning models, use only kerosene, No. 1 home heating fuel, or diesel. If diesel is used, add a soot remover to every tankful.



***Follow the maintenance instructions specified in the manual.***



# COMPONENT IDENTIFICATION

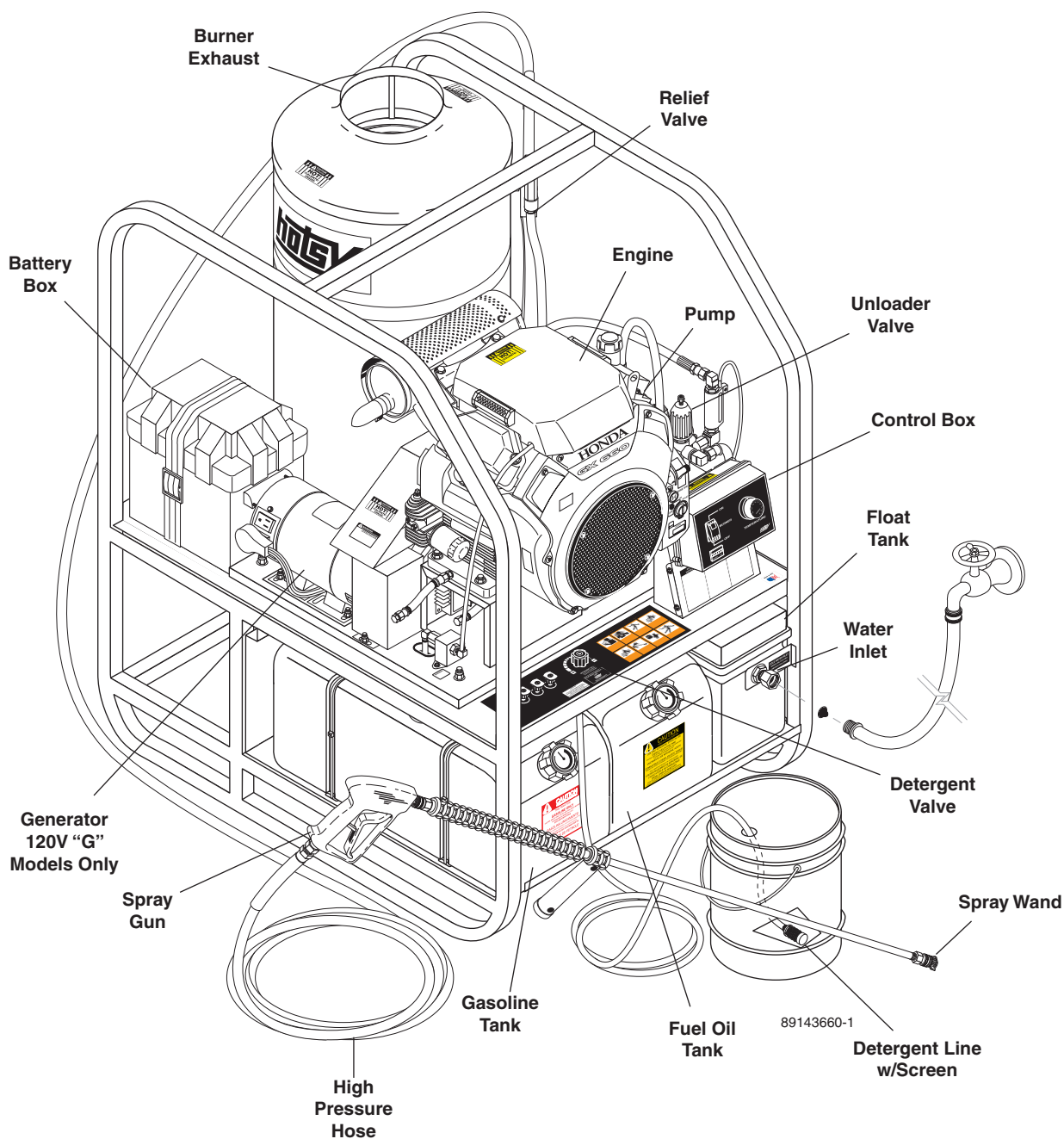

**Pump** — Delivers a specific gpm to the high pressure nozzle which develops pressure.

**Spray Gun** — Controls the application of water and detergent onto cleaning surface with trigger device. Includes safety latch.

**Detergent Valve** — Allows you to siphon and mix detergents

**Wand** — Must be connected to the spray gun.

**High Pressure Hose** — Connect one end to water pump high pressure discharge nipple and the other end to spray gun.

**Unloader Valve** — Safety device which, when the spray gun closes, prevents over pressurization.



# ASSEMBLY INSTRUCTIONS

## Unpacking

Unpack carefully. Wear safety glasses or goggles while unpacking, assembling, or operating pressure washer. If there are missing components or hidden damage, immediately contact carrier concerning discrepancies.

## Parts Included

- Pressure Washer
- Pressure Hose
- Pressure Nozzles (3 Ea.)
- Wand
- Trigger Gun
- Operations Manual
- Gasoline Engine Manual

## Pressure Hose, Trigger Gun and Wand

1. Install the pressure hose on the pressure washer as shown in **Figure 3**.

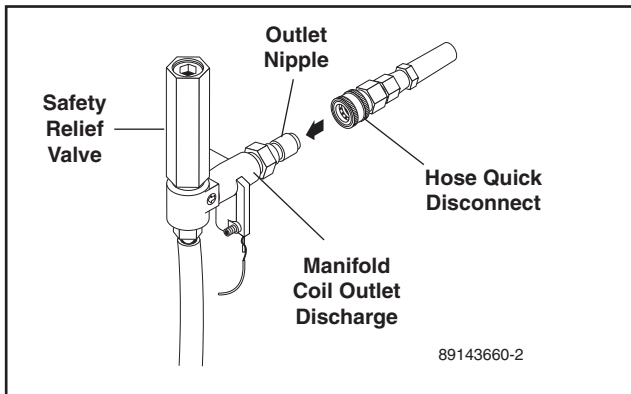

**Figure 3 - Pressure Hose Installation**

**NOTE: The pressure nozzle is not to be installed at this time.**

2. Assemble wand components as shown in **Figure 4**.

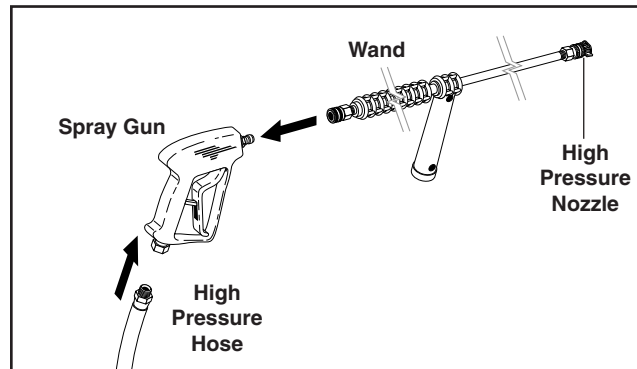

**Figure 4 - Trigger Gun/Wand Assembly**

3. Make sure all connections are secure.

# INSTALLATION

## Getting Started

**IMPORTANT:** Proper initial installation of equipment will assure more satisfactory performance, longer service life, and lower maintenance cost.

**IMPORTANT:** The use of backflow preventer on the water supply hose is recommended and may be required by local code.

The pressure washer should be run on a level surface and in a protected area where it is not readily influenced by outside forces such as strong winds, freezing temperatures, rain, etc. The pressure washer should be located to assure easy access for filling fluids, adjustment and maintenance. Normal precautions should be taken by the operator to prevent moisture from reaching the pressure washer. It is recommended that a partition be made between the wash area and the pressure washer to prevent direct spray from the high-pressure wand from coming in contact with the pressure washer. Moisture reaching the pressure washer will reduce its service life. All installations should comply with the local codes covering such installations.

**IMPORTANT:** DO NOT run machine indoors or in an enclosed area where high ambient temperatures exist. High ambient temperatures (above 100° F) can cause engine oil failure and will greatly reduce the engine's performance.

## Venting

**CAUTION:** All venting must be in accordance with applicable federal and state laws, and local ordinances. Consult local heating contractors.

If the pressure washer is to be used in an enclosed area, a flue must be installed to vent burner and engine exhaust to the outside atmosphere. Be sure the flue is the same size as the burner exhaust vent on the pressure washer lid. Poor draft will cause the pressure washer to soot and not operate properly. When selecting the location for installation, beware of poorly ventilated locations or areas where exhaust fans may cause an insufficient supply of oxygen. Proper combustion can only be obtained when there is a sufficient supply of oxygen available for the amount of fuel being burned. If it is necessary to install the machine in a poorly ventilated area, outside fresh air will have to be supplied to the machine. Locate the pressure washer so that the flue will be as straight as possible and protrude through the roof at a proper height and location to provide adequate draft. This oil fired pressure washer must have a draft regulator installed in the flue (available from most heating contractors). A draft regulator will permit proper upward flow of exhaust flue gases.

## Battery

**WARNING:** Batteries generate explosive gases during normal battery operation. DO NOT expose the battery to flame or sparks as these gases may ignite.

**WARNING:** Battery fluid is highly acidic. If battery fluid contacts skin or clothing, wash immediately with soap and water. If battery fluid enters eye, immediately flood eye with running cold water for at least 15 minutes and get immediate medical attention.

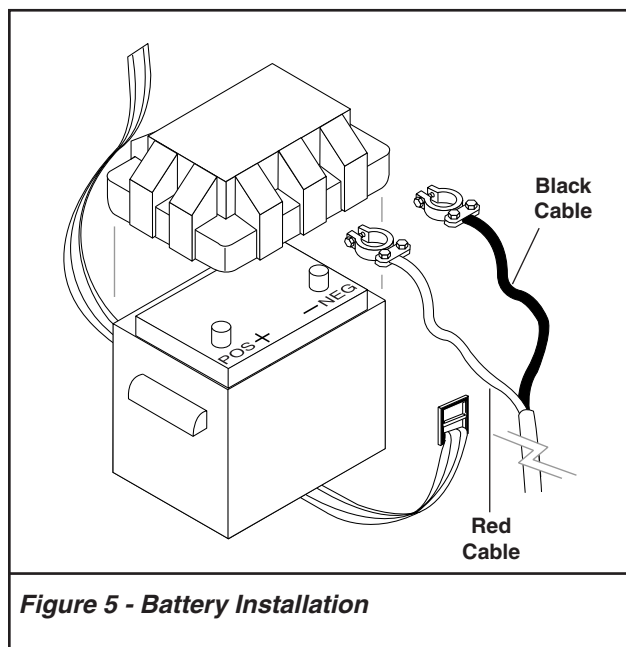

Figure 5 - Battery Installation

1. Refer to **Figure 5**.
2. Install battery (battery not included) in battery box as shown. Use a standard automotive battery minimum 500 CCA (Cold Cranking Amps). It is recommended that a dual cell battery (a battery with a separate cell for emergency starting) be used.
3. To reduce the possibility of sparking attach the battery cables in the following order. First attach the positive battery cable (red) to the positive "+" terminal of the battery. Next, attach the negative battery cable (black) to the negative "-" terminal of the battery. To disconnect the battery, remove the cables in the opposite order as installed.
4. Install battery box lid and secure with strap provided.

## Oil Burner

**Burner Air Adjustment:** The oil burner is preset for operation at altitudes below 3000 feet. If operated at higher altitudes, it may be necessary to adjust the air band setting. Adjust the air band for a #1 or #2 smoke spot on the Baccarat scale.

## INSTALLATION

### Beckett Oil Burner

To adjust, start machine and turn burner ON (refer to **Operation** for details). Loosen two locking screws found in the air shutter openings (refer to **Figure 6**) and close air shutter until black smoke appears from burner exhaust vent. Note air band position. Next, slowly open the air shutter until white smoke just starts to appear. Turn air shutter halfway back to the black smoke position previously noted. Tighten locking screws.

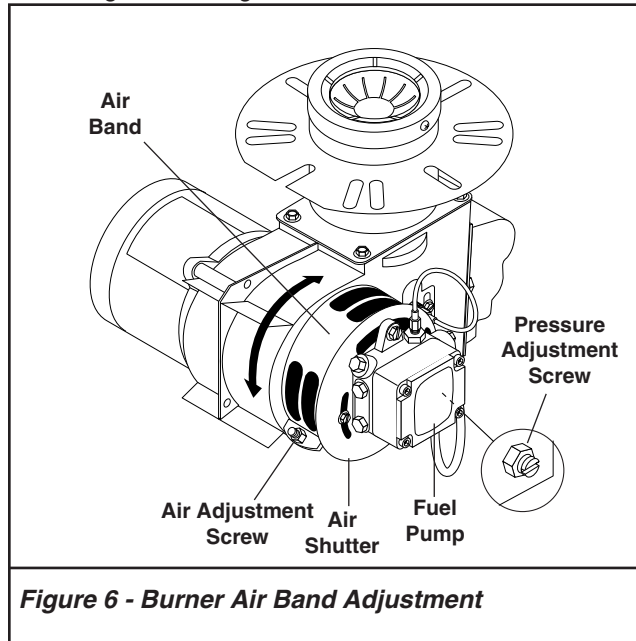

**Figure 6 - Burner Air Band Adjustment**

If the desired position cannot be obtained using only the air shutter, lock the air shutter in as close a position as can be obtained, then repeat the above procedure on the air band setting.

**CAUTION:** If white smoke appears from burner exhaust vent during start-up or operation, discontinue use and readjust air bands.

**NOTE:** If a flue is installed, have a professional serviceman adjust your burner for a #1 or #2 smoke spot on the Baccarat scale.

For additional burner component information, see **Figure 16**. It is recommended that the oil burner be serviced yearly or as needed. Contact your local service center.

### Hotsy Crossfire Oil Burner

**Burner Air Adjustment:** The oil burner on this machine is preset for operation at altitudes below 1000 feet. If operated at higher altitudes, it may be necessary to adjust the air band for a #1 or #2 smoke spot on the Bacharach scale.

To adjust, start machine and turn burner ON. Loosen two locking screws found on the air band and close air band until black smoke appears from burner exhaust vent. Note air band position. Next, slowly open the air band until white smoke just starts to appear. Turn air band halfway back to the previously noted position. Tighten locking screws.

### Hotsy Crossfire Oil Burner

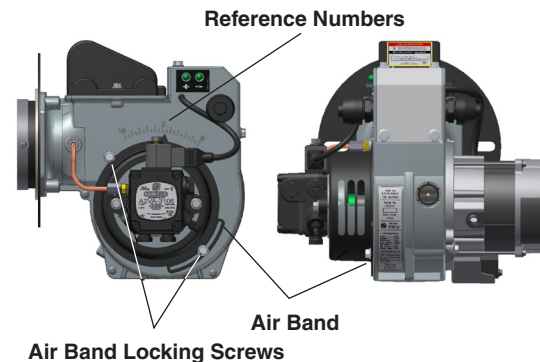

**CAUTION:** If white smoke appears from burner exhaust vent during start-up or operation, discontinue use and readjust air bands.

**NOTE:** If a flue is installed, have a professional serviceman adjust your burner for a #1 or #2 smoke spot on the Bacharach scale.

### Gasoline Engine

This gasoline engine is preset for operation at altitudes below 3000 feet above sea level. If operated at higher altitudes, it may be necessary to install a high altitude main jet in the carburetor. Contact an authorized engine sales and service center for details.

### Water Supply

This machine is designed to be connected to a pressurized (20 to 100 PSI) water supply, capable of maintaining a minimum of 6.0 GPM. If it is necessary to use a gravity feed water tank, the following plumbing modifications will be required.

A 1/2" NPT 3-way ball valve will need to be installed in the water inlet line. Refer to **Figure 7**. Hotsy recommends the use of Watts Regulator Valve #1/2 B6780 M1 (Hotsy P/N 921363) for this application. With this valve in place this machine will be capable of using both a pressurized or gravity feed water supply without additional modifications. For proper operation it is important that the valve be fully open for its intended supply. This will prevent air from being drawn into the system from the non active source. Also the pressure supply must still be connected to the float tank. The connection of a pressurized supply directly to the 3-way valve will prevent detergent from being drawn into the system.

# OPERATION INSTRUCTIONS

## Before Starting

**WARNING:** Check hoses, fittings, wand, trigger gun and fuel connections daily for signs of wear, cracks and looseness, replace as required.

1. Read all manuals provided with this pressure washer. Become familiar with location and function of all operating and safety controls.
2. Connect the water supply hose to the float tank water inlet (standard garden hose connector). The water faucet and supply hose must be capable of providing 6.0 GPM.
3. Fill the burner fuel tank. Use kerosene, #1 grade home heating oil, #1 or #2 diesel fuel. **DO NOT USE GASOLINE.**
4. Fill the gasoline tank. Use lead free gasoline minimum 86 octane. **DO NOT** use gasoline containing more than 10% ethanol, 15% MTBE, or 5% methanol.
5. Check pump and engine oil levels.
6. If detergents are to be used, only use detergent for pressure washers. Follow instructions on detergent container.

**IMPORTANT:** Before installing the pressure nozzle on initial start-up, turn on the water supply and allow water to run from the end of the wand until clear to prevent the pressure nozzle from clogging.

**IMPORTANT:** If the pressure washer has not been used for an extended period of time, remove the pressure nozzle from the end of the wand and turn on the water supply. Allow water to run from the end of the wand until clear.

7. Install the proper pressure nozzle for your cleaning needs on end of wand, refer to **Figure 8**.

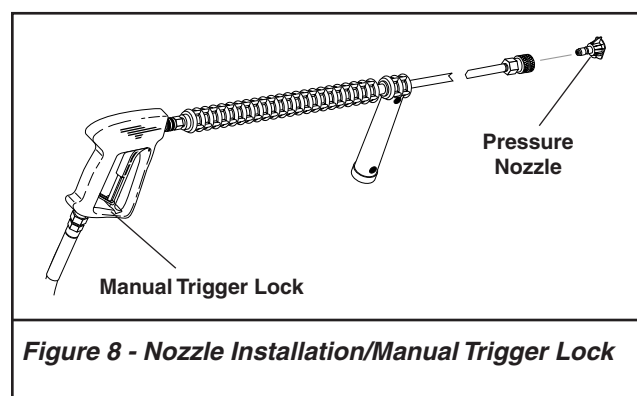

**Figure 8 - Nozzle Installation/Manual Trigger Lock**

**IMPORTANT:** The trigger gun provided with this pressure washer is equipped with a manual trigger lock to prevent accidental operation of the trigger gun, refer to **Figure 8**. The manual trigger lock should be used whenever the trigger gun is not in use.

## Fuel Pump

Some 1200 models are equipped with an electric fuel pump which operates only when the engine is running. The pump is primed when the key switch is held in the

start position. In the event that the engine stalls for any reason the fuel pump will shut off.

**WARNING:** The fuel pump installed on this machine has been adjusted at the factory to provide a maximum pressure of 1.3-1.7 PSI at the pump outlet. Whenever the fuel pump is replaced the new pump must be adjusted using the following procedure:

1. Place the ignition switch in the OFF position.
2. Disconnect the fuel line from the engine mounted fuel filter and connect a fuel pump pressure gauge (0-5 PSI) to the fuel pump discharge line.
3. Turn the ignition key to the start position and observe pressure gauge. Pressure must be set to between 1.3 and 1.7 PSI. It will be necessary to bleed off accumulated pressure in line prior to each gauge reading. Turn screw on top of fuel pump to adjust pressure (CCW to decrease, CW to increase).
4. After adjustment, reconnect fuel line to engine mounted fuel filter and start machine. Check for fuel leakage and tighten fittings/clamps as required.

## To Start

**DANGER:** DO NOT point wand or spray gun at yourself or at any person. Bodily injury may result from water under high pressure.

**IMPORTANT:** The water must be turned on before starting. Running the pump dry will cause damage and void warranty.

**IMPORTANT:** DO NOT allow the machine to run with trigger gun closed for more than 3 minutes at any time or damage to pump may occur.

1. Turn water ON.
2. Hold wand firmly with trigger gun in the closed position.
3. Turn fuel shut-off valve counterclockwise (CCW) to open. Move choke lever to full choke position. Choke may not be needed on warm engine.
4. Move throttle control to half throttle.
5. Turn key on engine clockwise (CW) hold until engine starts. **DO NOT** crank engine for longer than 15 seconds at any one time or starter damage may occur. If the engine does not start, it may have air in the gas lines and be unable to pull gasoline from the fuel tank. This symptom may appear if the engine has not been run recently or had been run until all gasoline was depleted from gas lines.
6. When the engine starts, move choke lever until engine runs smoothly. Then move throttle control to full throttle. When engine warms, move choke to no choke position.

**IMPORTANT:** To allow for proper battery charging and AC generator operation the throttle control MUST be kept in full throttle position as soon as choke lever is placed in no choke position.

---

## OPERATION INSTRUCTIONS

---

7. Holding wand firmly, squeeze the trigger gun open. Allow air to purge from system.
8. If hot water is desired, adjust the thermostat to proper temperature. Close the trigger gun and turn burner switch ON.

***IMPORTANT: The throttle control must be in the full throttle position or damage to the AC generator or burner may result.***

9. Open the trigger gun. The burner will fire immediately with a puff of smoke. If smoke continues, refer to the Troubleshooting Guide in this manual. When the trigger gun is closed or the temperature setting is reached, the burner will automatically turn off.



# DETERGENTS & GENERAL WASHING TECHNIQUES



**WARNING:** Some detergents may be harmful if inhaled or ingested, causing severe nausea, fainting or poisoning. The harmful elements may cause property damage or severe injury.

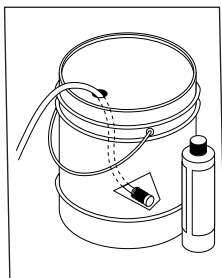

**STEP 1:** Use detergent designed specifically for pressure washers. Household detergents could damage the pump. Prepare detergent solution as required by the manufacturer. Fill a container with pressure washer detergent. Place the filter end of detergent suction tube into the detergent container.

**STEP 2:** With the engine running, pull trigger to operate machine. Liquid detergent is drawn into the machine and mixed with water. Apply detergent to work area. Do not allow detergent to dry on surface.

**IMPORTANT:** You must flush the detergent after each use by placing the suction tube into a bucket of clean water, open detergent valves then run the pressure washer for 1-2 minutes.

## THERMAL PUMP PROTECTION

If you run your pressure washer for 3-5 minutes without pressing the trigger on the spray gun, circulating water in the pump can reach high temperatures. When the water reaches this temperature, the pump protector engages and cools the pump by discharging the warm water onto the ground. This thermal device prevents internal damage to the pump.

## CLEANING TIPS

Pre-rinse cleaning surface with fresh water. Place detergent suction tube directly into cleaning solution and apply to surface at low pressure (for best results, limit your work area to sections approximately 6 feet square and always apply detergent from bottom to top). Allow detergent to remain on surface 1-3 minutes. Do not allow detergent to dry on surface. If surface appears to be drying, simply wet down surface with fresh water. If needed, use brush to remove stubborn dirt. Rinse at high pressure from top to bottom in an even sweeping motion keeping the spray nozzle approximately 1 foot from cleaning surface. Use overlapping strokes as you clean and rinse any surface. For best surface cleaning action spray at a slight angle.

### Recommendations:

- Before cleaning any surface, an inconspicuous area should be cleaned to test spray pattern and distance for maximum cleaning results.
- If painted surfaces are peeling or chipping, use extreme caution as pressure washer may remove the loose paint from the surface.
- Keep the spray nozzle a safe distance from the surface you plan to clean. High pressure wash a small area, then check the surface for damage. If no damage is found, continue to pressure washing.

### **CAUTION - Never use:**

- Bleach, chlorine products and other corrosive chemicals
- Liquids containing solvents (i.e., paint thinner, gasoline, oils)
- Tri-sodium phosphate products
- Ammonia products
- Acid-based products

These chemicals will harm the machine and will damage the surface being cleaned.

## RINSING

It will take a few seconds for the detergent to clear. Apply safety latch to spray gun and close detergent valve. Select and install the desired high pressure nozzle.

---

## SHUTDOWN INSTRUCTIONS & STORAGE

---

1. If detergents were used, draw clear water through the system to purge detergent.
2. If burner was used, turn OFF burner switch, and allow pump to run cold water through coil.
3. Move throttle control to idle position.
4. Turn key on engine counterclockwise (CCW) to OFF position.
5. Turn OFF fuel shut-off valve.
6. Turn OFF water supply.
7. Squeeze trigger gun open to relieve system pressure.

---

### STORAGE

---

***DANGER: Do not store flammable liquids (gasoline, solvents, etc.) near pressure washer, or in non-ventilated areas.***

Protect from freezing by storing in a heated area, or by flushing the system with antifreeze. To flush the system, fill the float tank with antifreeze and remove spray nozzle from wand. Start the machine and allow it to run until antifreeze flows from the end of the wand. Place end of wand into float tank and circulate the antifreeze through system for several minutes. Open and close the trigger gun several times to circulate antifreeze through the unloader valve. Place detergent line into the float tank. Open the detergent metering valve to draw antifreeze into the detergent system.

If the pressure washer is not to be used for a considerable length of time, it is recommended to flush the system with antifreeze for rust protection.



# MAINTENANCE

**WARNING:** *Unauthorized machine modification or use of non-approved replacement parts may cause personal injury and/or property damage and will void the manufacturer warranty.*

## Pump

Use HOTSYS Pump Oil (P/N 315068) or equivalent 30W non-detergent oil for pump crankcase. Crankcase must be filled to the full mark on the dipstick or to center of sight glass window found on the rear of the pump. During the break-in period, make sure the oil is changed after the first 25 hours of operation. After that, replace oil every 3 months or 300 hours, whichever comes first.

## DO NOT:

1. Pump acids.
2. Fail to winterize in freezing temperatures.
3. Allow pump to run dry.
4. Allow machine to run with trigger gun closed for more than 3 minutes at any one time or damage to pump may occur.

## DO:

1. Use a water softener on the water system if known to be high in mineral content.
2. Use only high quality detergents and follow manufacturer's mix recommendations.
3. Immediately after using detergent solutions the system should be flushed thoroughly with clear water.
4. Clean strainer screen on detergent line periodically.

## Unloader Valve

**WARNING:** *The unloader valve on this pressure washer has been factory set and sealed and is a field nonadjustable part. Tampering with the factory setting may cause personal injury and/or property damage, and will void the manufacturer warranty.*

## Burner Fuel Filter

Drain water that has accumulated in fuel filter and clean filter element as needed.

## Heating Coil

**Coil De scaling:** In hard water areas, scale buildup within the heating coil will occur. Scale deposits will decrease the water temperature rise and may eventually clog the heating coil. Contact your local service center when de scaling is needed.

**Coil De sooting:** Poor grades of fuel oil or inadequate combustion air will cause heavy soot buildup on the outside surface of the heating coil. This will restrict the airflow through the coil, further aggravating the soot buildup. Contact your local service center when de sooting is needed.

## Engine

Refer to **engine manual** provided with this pressure washer for recommended maintenance.

## Oil Burner Blower Motor

The motor bearings are permanently lubricated and will not require any additional lubrication.

## Battery

Refer to **battery manufacturer's literature** for recommended maintenance

## TROUBLESHOOTING

PROBLEM	POSSIBLE CAUSE	SOLUTION
<b>ENGINE WILL NOT RUN</b>	No fuel	Replenish supply.
	Low battery	Charge battery.
	Poor battery cable connection	Clean battery terminals and check cables.
	<b>Refer to provided engine manual for additional troubleshooting.</b>	
<b>NO WATER FROM PRESSURE NOZZLE</b>	Pressure nozzle clogged	Clean pressure nozzle.
	Inlet water screen clogged.	Clean.
	Pumping sucking air	Fill the detergent container. Check for loose hose clamps or fittings.
<b>POOR OR NO DETERGENT FLOW</b>	Low detergent level	Replenish supply.
	Detergent screen clogged	Clean.
	Detergent metering valve not opening	Check that handle or knob is not slipping on shaft.
	Pressure nozzle clogged	Clean.
<b>LOW PRESSURE FROM SPRAY NOZZLE.</b>	Inlet clogged	Clean
	Spray nozzle worn or incorrect size	Replace.
	Inadequate water supply	Increase water supply.
	Pump sucking air	Fill the detergent container. Check for loose hose clamps or fittings.
<b>UNLOADER VALVE CYCLES WHEN TRIGGER GUN IS OPEN OR CLOSED</b>	Air in system	Open and close trigger gun several times.
	Defective unloader valve.	Repair or replace.
	Water leak between unloader valve and trigger gun.	Check fittings, hose and trigger gun for leaks. Repair or replace.
<b>BURNER WILL NOT IGNITE WHEN TRIGGER GUN IS OPEN</b>	No fuel	Replenish supply.
	Adjustable thermostat set too low	Raise temperature setting.
	Defective pressure switch	Repair or replace.
	Electrodes are dirty or out of adjustment No AC generator output	Refer to <b>Oil Burner Manual</b> provided with machine. Check AC generator.
<b>BURNER SMOKES OR HAS OBNOXIOUS ODOR</b>	Air bands need to be adjusted	Readjust. Refer to <b>Oil Burner Section</b> under <b>Installation</b> .
	Improper fuel	Use kerosene, #1 Grade Home Heating Oil, #1 or #2 Diesel Fuel. <b>DO NOT USE GASLONE.</b>

---

## TROUBLESHOOTING

---

### IMPORTANT

If the pressure washer demonstrates other symptoms or the corrective actions listed do not correct the problem, contact the local authorized Hotsy Service Center. The Hotsy Service Center can be identified by visiting [www.hotsy.com](http://www.hotsy.com) or by calling **1-800-525-1976**.

**When ordering from your dealer, please provide the following:**

**Model Number:** \_\_\_\_\_

**Machine Serial Number:** \_\_\_\_\_

**Component Part Number:** \_\_\_\_\_

**Description:** \_\_\_\_\_



**HOTSY LIMITED NEW PRODUCT WARRANTY  
PRESSURE WASHERS  
WHAT THIS WARRANTY COVERS**

All Hotsy pressure washers are warranted by Hotsy to the original purchaser to be free from defects in materials and workmanship under normal use, for the periods specified below. This Limited Warranty is subject to the exclusions shown below, is calculated from the date of the original purchase, and applies to the original components only. Any parts replaced under this warranty will assume the remainder of the part's warranty period.

**SEVEN YEAR PARTS AND ONE YEAR LABOR WARRANTY:**

Components manufactured by Hotsy, such as frames, handles, top and bottom wraps, float tanks, fuel tanks, belt guards, and internal components on the oil-end of HOTSYS manufactured pumps. General, AR, Liberty, Comet and swash and wobble plate pumps have a one year warranty. Heating coils have a five year warranty from date of original machine purchase.

**ONE YEAR PARTS AND ONE YEAR LABOR WARRANTY:**

All other components, excluding normal wear items as described below, will be warranted for one year on parts and labor. Parts and labor warranty on these parts will be for one year regardless of the duration of the original component manufacturer's part warranty.

**WARRANTY PROVIDED BY OTHER MANUFACTURERS:**

Motors, generators, and engines, which are warranted by their respective manufacturers, are serviced through these manufacturers' local authorized service centers. Hotsy is not authorized and has no responsibility to provide warranty service for such components.

**WHAT THIS WARRANTY DOES NOT COVER**

This warranty does not cover the following items:

1. Normal wear items, such as nozzles, spray guns, discharge hoses, wands, quick couplers, seals, filters, gaskets, O-rings, packings, pistons, pump valve assemblies, strainers, belts, brushes, rupture disks, fuses, pump protectors.
2. Damage or malfunctions resulting from accidents, abuse, modifications, alterations, incorrect installation, improper servicing, failure to follow manufacturer's maintenance instructions, or use of the equipment beyond its stated usage specifications as contained in the operator's manual.
3. Damage due to freezing, chemical deterioration, scale build up, rust, corrosion, or thermal expansion.
4. Damage to components from fluctuations in electrical or water supply.
5. Normal maintenance service, including adjustments, fuel system cleaning, and clearing of obstructions.
6. Transportation to service center, field labor charges, or freight damage.

**WHAT YOU MUST DO TO OBTAIN WARRANTY SERVICE**

In order to obtain warranty service on items warranted by Hotsy, you must return the product to your Authorized Hotsy Distributor, freight prepaid, with proof of purchase, within the applicable warranty period. If the product is permanently installed, you must notify your Authorized Hotsy Distributor of the defect. Your Authorized Hotsy Distributor will file a claim with Hotsy, who must subsequently verify the defect. In most cases, the part must be returned to Hotsy freight prepaid with the claim. For warranty service on components warranted by other manufacturer's, your Authorized Hotsy Distributor can help you obtain warranty service through these manufacturers' local authorized service centers.

**LIMITATION OF LIABILITY**

Hotsy's liability for special, incidental, or consequential damages is expressly disclaimed. In no event shall Hotsy's liability exceed the purchase price of the product in question. Hotsy makes every effort to ensure that all illustrations and specifications are correct, however, these do not imply a warranty that the product is merchantable or fit for a particular purpose, or that the product will actually conform to the illustrations and specifications. Our obligation under this warranty is expressly limited at our option to the replacement or repair at a service facility or factory designated by us, of such part or parts as inspection shall disclose to have been defective. **THE WARRANTY CONTAINED HEREIN IS IN LIEU OF ALL OTHER WARRANTIES, EXPRESS OR IMPLIED, INCLUDING ANY IMPLIED WARRANTY OF MERCHANTABILITY OR FITNESS FOR A PARTICULAR PURPOSE ARE EXPRESSLY LIMITED TO THE DURATION OF THIS WRITTEN WARRANTY.** Hotsy does not authorize any other party, including authorized Hotsy Distributors, to make any representation or promise on behalf of Hotsy, or to modify the terms, conditions, or limitations in any way. It is the buyer's responsibility to ensure that the installation and use of Hotsy products conforms to local codes. While Hotsy attempts to assure that its products meet national codes, it cannot be responsible for how the customer chooses to use or install the product. Some states do not allow limitations on how long an implied warranty lasts or the exclusion or limitation of incidental or consequential damages, so the above limitation or exclusion may not apply to you. This warranty gives you specific legal rights and you may also have other rights which vary from state to state.

**HOTSY**

[www.hotsy.com](http://www.hotsy.com)

---

If you are looking for replacement parts for your Hotsy, please contact your local dealer. You can find a dealer by calling Hotsy at 800-525-1976 or by visiting [www.hotsy.com](http://www.hotsy.com).

---

If you need service on your pressure washer, contact your local Hotsy dealer or visit [www.Hotsy.com](http://www.Hotsy.com). Smart phone users scan the code below to link directly to the Service Request page.

