

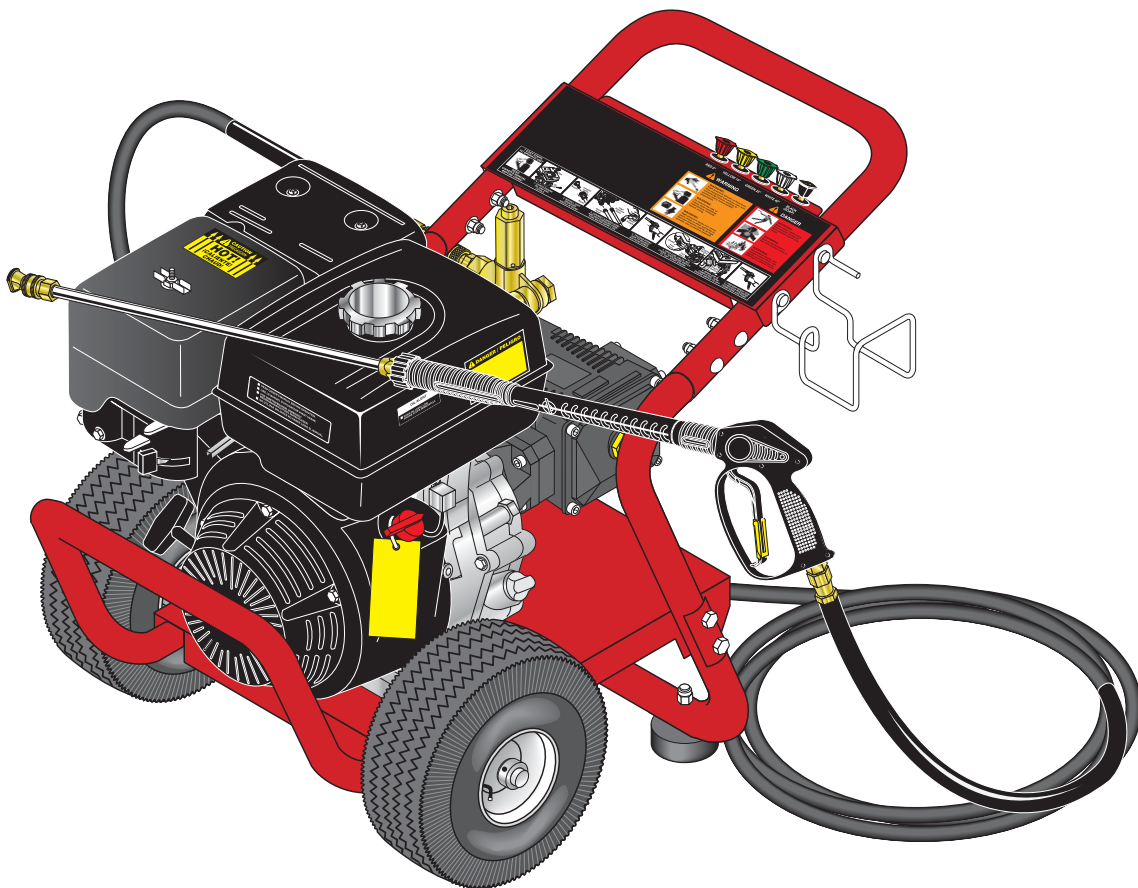

DB

OPERATOR'S MANUAL

- | | | |
|-----------|-----------|-----------|
| ■ DB-2527 | ■ DB-2323 | ■ DB-2324 |
| | ■ DB-3030 | ■ DB-3835 |
-



For technical assistance or the dealer nearest you consult our web page at
www.hotsty.com

8.914-449.0

CONTENTS

Important Safety Information	3-4
Component Identification	5
Assembly Instructions.....	6
Operating Instructions.....	7-8
Applying Detergent and General Operating Techniques.....	9
Shut Down and Clean-Up	10
Storage	10
Troubleshooting	11-12
Preventative Maintenance	13
Oil Change Record	13
Warranty	

Model Number _____

Serial Number _____

Date of Purchase _____

The model and serial numbers will be found on a decal attached to the pressure washer. You should record both serial number and date of purchase and keep in a safe place for future reference.

INTRODUCTION & IMPORTANT SAFETY INFORMATION

Thank you for purchasing this Pressure Washer. We reserve the right to make changes at any time without incurring any obligation.

Owner/User Responsibility:

The owner and/or user must have an understanding of the manufacturer's operating instructions and warnings before using this pressure washer. Warning information should be emphasized and understood. If the operator is not fluent in English, the manufacturer's instructions and warnings shall be read to and discussed with the operator in the operator's native language by the purchaser/owner, making sure that the operator comprehends its contents.

Owner and/or user must study and maintain for future reference the manufacturers' instructions.

The operator must know how to stop the machine quickly and understand the operation of all controls. Never permit anyone to operate the engine without proper instructions.

This manual should be considered a permanent part of the machine and should remain with it if machine is resold.

When ordering parts, please specify model and serial number. Use only identical replacement parts.

This machine is to be used only by trained operators.

IMPORTANT SAFETY INFORMATION

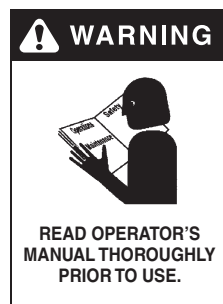

WARNING: To reduce the risk of injury, read operating instructions carefully before using.

1. Read the owner's manual thoroughly. Failure to follow instructions could cause malfunction of the machine and result in death, serious bodily injury and/or property damage.

2. Know how to stop the machine and bleed pressure quickly. Be thoroughly familiar with the controls.
3. Stay alert — watch what you are doing.

4. All installations must comply with local codes. Contact your electrician, plumber, utility company or the selling distributor for specific details.



WARNING: Risk of asphyxiation. Use this product only in a well ventilated area.

5. Avoid installing machines in small areas or near exhaust fans. Exhaust contains poisonous carbon monoxide gas; exposure may cause loss of consciousness and may lead to death. It also contains

chemicals known, in certain quantities, to cause cancer, birth defects or other reproductive harm.



WARNING: Risk of fire. Do not add fuel when the product is operating.

WARNING: Risk of explosion — do not spray flammable liquids.

6. Do not place machine near flammable objects as the engine is hot.

WARNING: This product contains chemicals known to the state of California to cause cancer and birth defects or other reproductive harm. Operation of this equipment may create sparks that can start fires around dry vegetation. A spark arrester may be required. The operator should contact: Local fire agencies for laws or regulations relating to fire prevention requirements.

7. Allow engine to cool for 1-2 minutes before refueling. If any fuel is spilled, make sure the area is dry before testing the spark plug or starting the engine. (Fire and/or explosion may occur if this is not done.)

Gasoline engines on mobile or portable equipment shall be refueled:

- a. outdoors;
- b. with the engine on the equipment stopped;
- c. with no source of ignition within 10 feet of the dispensing point; and
- d. with an allowance made for expansion of the fuel should the equipment be exposed to a higher ambient temperature.

In an overfilling situation, additional precautions are necessary to ensure that the situation is handled in a safe manner.

WARNING: Risk of injury. Disconnect battery ground terminal before servicing.

IMPORTANT SAFETY INFORMATION

8. Transport/repair with fuel tank EMPTY or with fuel shut-off valve OFF.

WARNING



KEEP WATER SPRAY AWAY FROM ELECTRICAL WIRING.

WARNING: Keep wand, hose, and water spray away from electric wiring or fatal electric shock may result.

9. Do not spray water on or near electrical components.

WARNING



RISK OF EXPLOSION: DO NOT SPRAY FLAMMABLE LIQUIDS.

WARNING: Flammable liquids can create fumes which can ignite, causing property damage or severe injury.

WARNING: Risk of explosion — Do not spray flammable liquids.

10. Keep operating area clear of all persons.

WARNING: This machine exceeds 85 db appropriate ear protection must be worn.

WARNING



EAR PROTECTION MUST BE WORN

WARNING



USE PROTECTIVE EYE WEAR AND CLOTHING WHEN OPERATING THIS EQUIPMENT.

WARNING: High pressure spray can cause paint chips or other particles to become airborne and fly at high speeds. To avoid personal injury, eye, hand and foot safety devices must be worn.

11. Eye, hand, and foot protection must be worn when using this equipment.

WARNING



TRIGGER GUN KICKS BACK - HOLD WITH BOTH HANDS

WARNING: Grip cleaning wand securely with both hands before starting. Failure to do this could result in injury from a whipping wand.

12. To reduce the risk of injury, close supervision is necessary when a machine is used near children. Do not allow children

to operate the pressure washer. **This machine must be attended during operation.**

WARNING



RISK OF INJECTION OR SEVERE INJURY TO PERSONS. KEEP CLEAR OF NOZZLE.

WARNING: High pressure developed by these machines will cause personal injury or equipment damage. Keep clear of nozzle. Use caution when operating. Do not direct discharge stream at people, or severe injury or death will result.

13. Never make adjustments on machine while in operation.

14. Be certain all quick coupler fittings are secured before using pressure washer.

WARNING



PROTECT FROM FREEZING

WARNING: Protect machine from freezing.

15. To keep machine in best operating conditions, it is important you protect machine from freezing. Failure to protect machine from freezing could cause malfunction of the machine and result in death,

serious bodily injury, and/or property damage. Follow storage instructions specified in this manual.

16. The best insurance against an accident is precaution and knowledge of the machine.

WARNING



RISK OF INJURY FROM FALLS WHEN USING LADDER.

WARNING: Be extremely careful when using a ladder, scaffolding or any other relatively unstable location. The cleaning area should have adequate slopes and drainage to reduce the possibility of a fall due to slippery surfaces.

17. Do not overreach or stand on unstable support. Keep good footing and balance at all times.

18. Do not operate this machine when fatigued or under the influence of alcohol, prescription medications, or drugs.

19. Inlet water must be clean fresh water and no hotter than 90°F.

20. Manufacturer will not be liable for any changes made to our standard machines or any components not purchased from us.

21. Do not allow acids, caustic or abrasive fluids to pass through the pump.

22. Never run pump dry or leave spray gun closed longer than 1-2 minutes.



Follow the maintenance instructions specified in the manual.

COMPONENT IDENTIFICATION

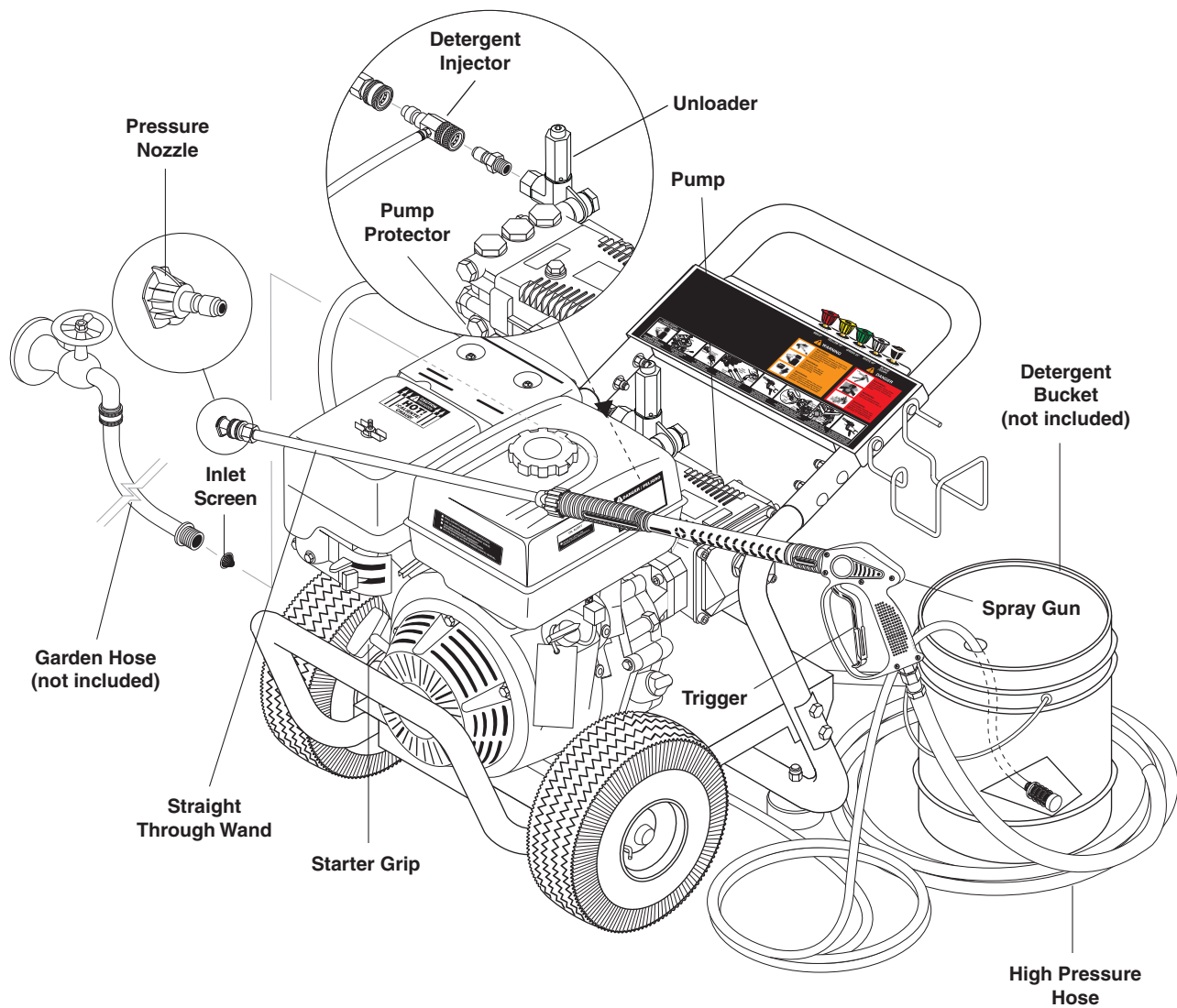

Pump — Develops high pressure.

Starter Grip— Used for starting the engine manually.

Spray Gun — Controls the application of water and detergent onto cleaning surface with trigger device. Includes safety latch.

Detergent Injector — Allows you to siphon and mix detergents.

Wand — Must be connected to the spray gun.

High Pressure Hose — Connect one end to water pump discharge nipple and the other end to spray gun.

Pump Protector — Cycles fresh cool water through pump when recirculating water reaches 140°F.

Note: If trigger on spray gun is released for more than 1-2 minutes, water will leak from valve. Warm water will discharge from pump protector onto floor. This system prevents internal pump damage.

ASSEMBLY INSTRUCTIONS

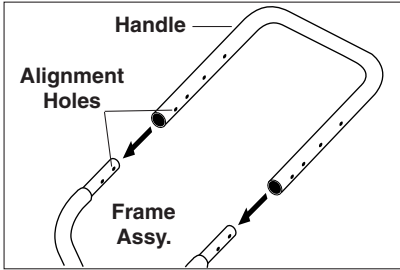

STEP 1: Attach the handle to the frame of the pressure washer. **Note:** It may be necessary to move the handle supports from side to side in order to align the handle so it will slide over the frame supports.

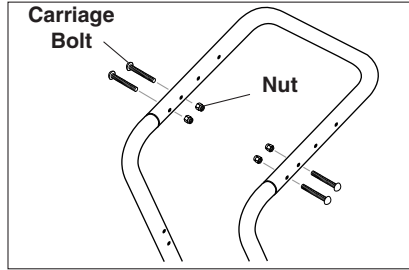

STEP 2: Insert the carriage bolt through the holes from the outside of the unit and attach a nut from the inside of the machine. Tighten nuts.

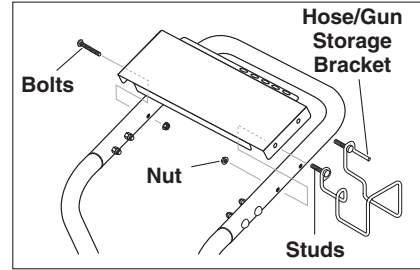

STEP 3: Attach the spray gun/hose storage handle and bracket to handle. Tighten nuts.

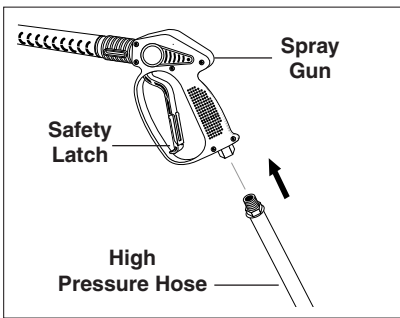

STEP 4: Attach the high pressure hose to the spray gun using teflon tape on hose threads.

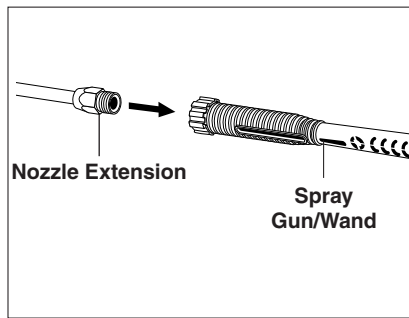

STEP 5: Attach nozzle extension to spray gun/wand. Tighten both by hand.

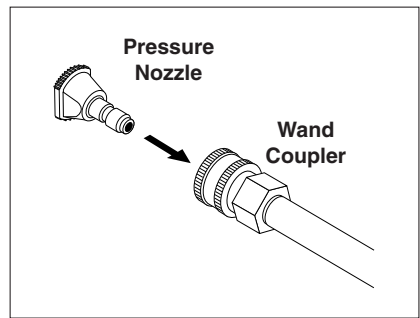

STEP 6: Pull spring-loaded collar of the wand coupler back to insert your choice of pressure nozzle.

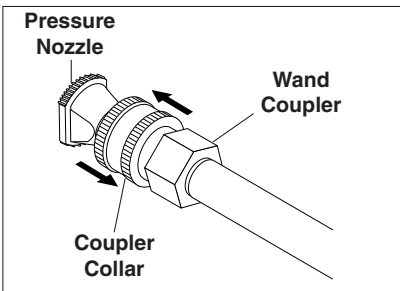

STEP 7: Release the coupler collar and push the nozzle until the collar clicks. Pull the nozzle to make sure it is seated properly.

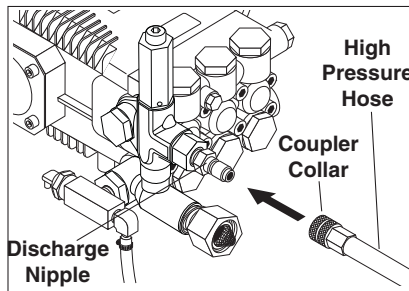

STEP 8: Connect the high pressure hose to the discharge nipple. Push coupler collar forward until secure.

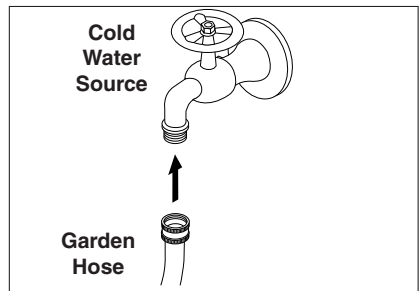

STEP 9: Connect garden hose to the cold water source.

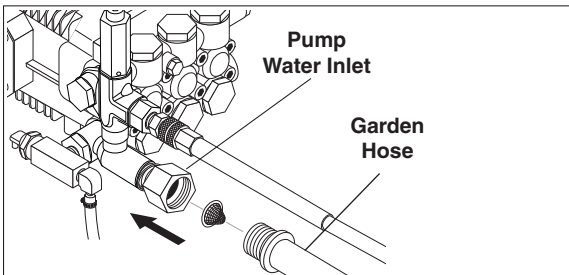

STEP 10: Check inlet filters, remove debris, then connect the garden hose to pump water inlet. **CAUTION: Do not run the pump without water or pump damage will result.**

OPERATING INSTRUCTIONS

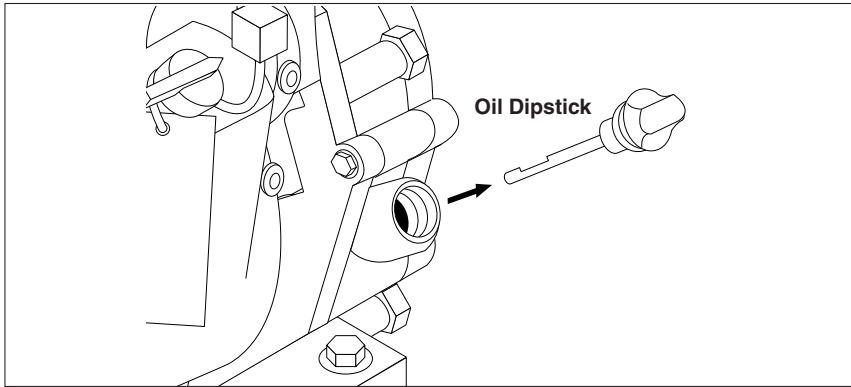

STEP 1: Check engine oil level. Oil level should be level with the bottom of the oil filler neck. Be sure the machine is level when checking the oil level. (Refer to the engine's operating manual included with machine.) We recommend that the oil be changed after the first 5 hours of use, then once every 50 hours. **Note:** Improper oil levels will cause low oil sensor to shut off engine. **IMPORTANT! Do not run engine with high or low oil levels as this will cause engine damage.**

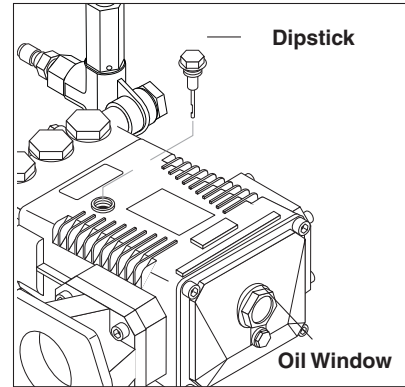

STEP 2: Remove shipping cap and install oil dipstick. Check pump oil level by using dipstick or observe oil level in oil window (if equipped). Use 40 wt. non detergent oil. The Legacy Axial Pump does not require maintenance. Attempting to check oil on this pump may damage it and will void your pump warranty.

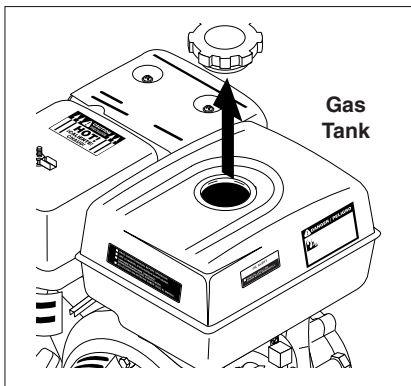

STEP 3: Fill gas tank with unleaded gasoline. Do not use leaded gasoline.

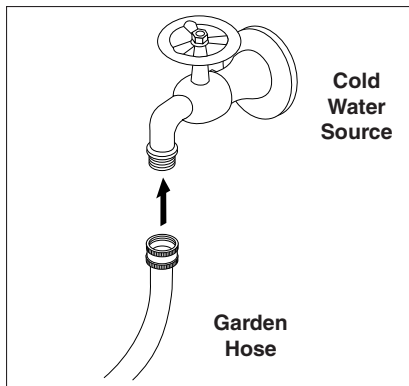

STEP 4: Connect garden hose to the cold water source and turn water on completely. Never use hot water.

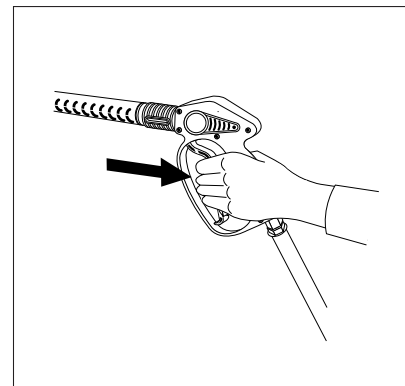

STEP 5: Trigger the spray gun to eliminate trapped air then wait for a steady flow of water to emerge from the spray nozzle.

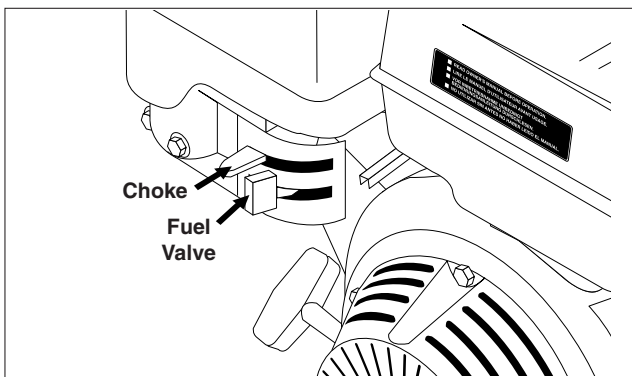

STEP 6: Rotate the fuel shut-off valve to the "On" position. Slide the fuel valve lever to the "ON" position. When the engine is not in use, leave the fuel valve in the "OFF" position.

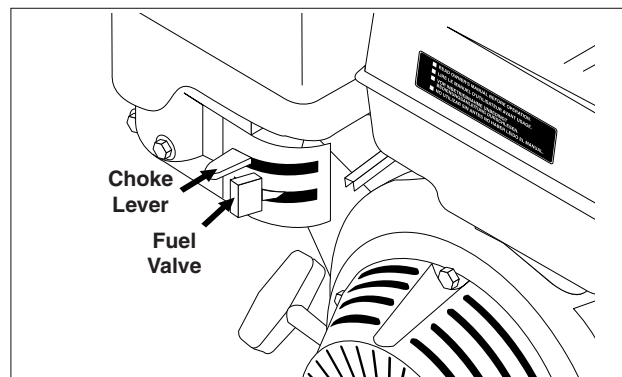

STEP 7: Move the choke lever to the "Choke" position (on a warm engine, leave the choke lever in the run position). Move the choke lever to the "Closed" position. To restart a warm engine, leave the choke lever in the "Open" position.

OPERATING INSTRUCTIONS (CON'T)

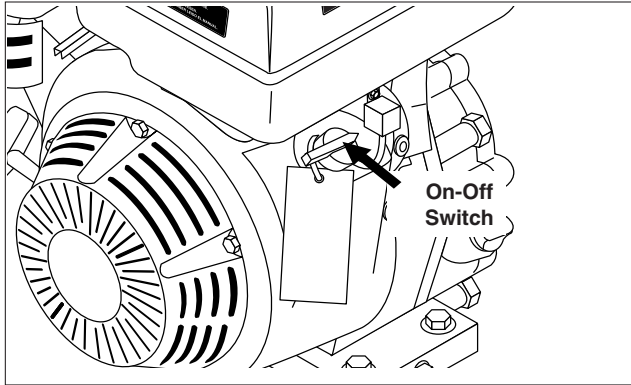

STEP 8: Turn the engine switch to "On" position. On Briggs engines, move the throttle lever to "Fast" position, shown on the engine as a rabbit.

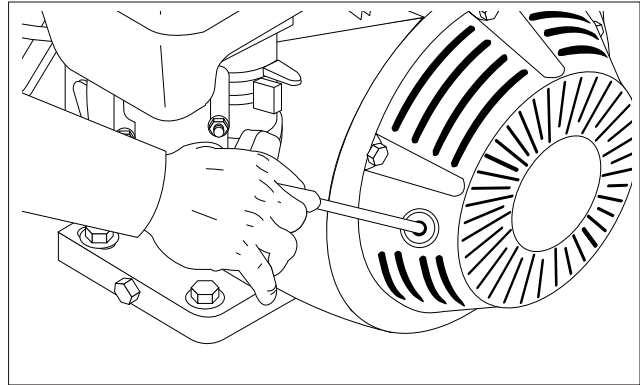

STEP 9: Pull the starter grip. If the engine fails to start after 2 pulls, squeeze the trigger gun to release pressure and repeat step. Return starter gently. After the engine warms up enough to run smoothly, move choke to run position and throttle to fast position.

CAUTION: Small engines may kick back. Do not hold pull starter grip tightly in hand.

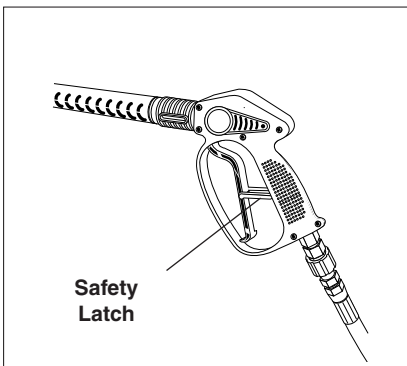

WARNING! Never replace nozzles without engaging the safety latch on the spray gun trigger.

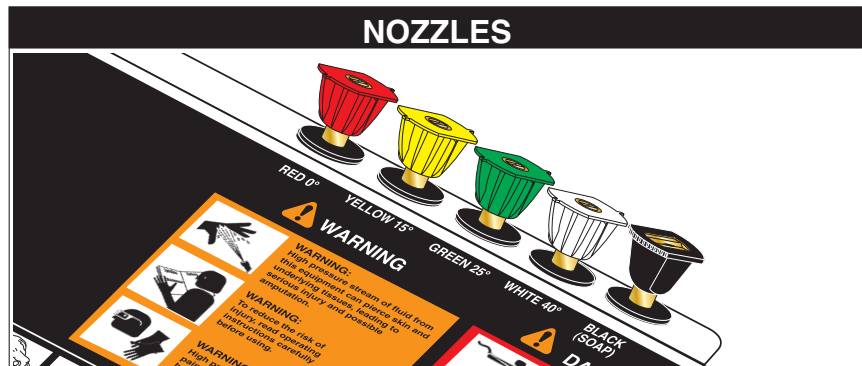

The five color-coded quick connect nozzles provide a wide array of spray widths from 0° to 40° and are easily accessible when placed in the convenient rubber nozzle holder, which is provided on the front of the machine.

NOTE: For a more gentle rinse, select the white 40° or green 25° nozzle. To scour the surface, select the yellow 15° or red 0° nozzle. To apply detergent select the black nozzle.

DETERGENT AND GENERAL CLEANING TECHNIQUES



WARNING: Some detergents may be harmful if inhaled or ingested, causing severe nausea, fainting or poisoning. The harmful elements may cause property damage or severe injury.

STEP 1: Connect detergent injector to discharge nipple on machine. Connect high pressure hose to injector with quick coupler. (Check to make sure locking coupler sleeves are in proper position before applying water pressure).

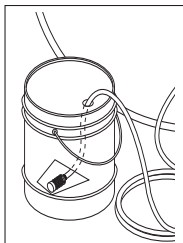
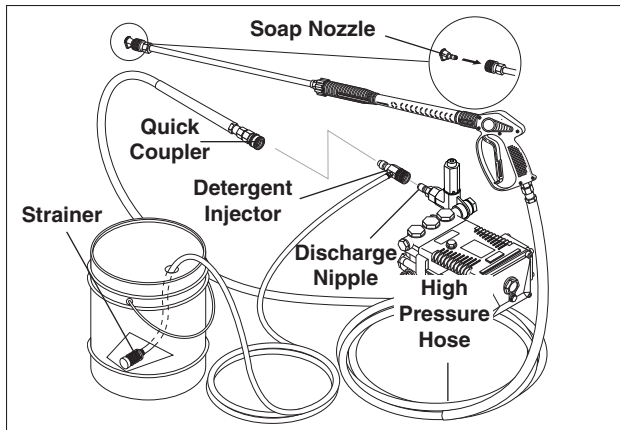

STEP 2: Use detergent designed specifically for pressure washers. Household detergents could damage the pump. Prepare detergent solution as required by manufacturer. Fill a container with pressure washer detergent. Place filter end of detergent suction tube into detergent container.

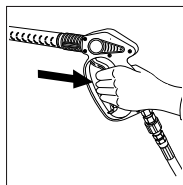

STEP 3: With safety latch on spray gun engaged, secure black detergent nozzle into quick coupler. **NOTE:** Detergent cannot be applied using red, yellow, green or white nozzles.

STEP 4: With the engine running, pull trigger to operate machine. Liquid detergent is drawn into the machine and mixed with water. Apply detergent to work area. Do not allow detergent to dry on surface.

IMPORTANT: You must flush the detergent injection system after each use by placing the suction tube into a bucket of clean water, then run the pressure washer in low pressure for 1-2 minutes.

THERMAL PUMP PROTECTION

If you run the engine on your pressure washer for 1-2 minutes without pressing the trigger on the spray gun, circulating water in the pump can reach high temperatures. When the water reaches this temperature, the pump protector engages and cools the pump by discharging the warm water onto the ground. This thermal device prevents internal damage to the pump.

CLEANING TIPS

Pre-rinse cleaning surface with fresh water. Place detergent suction tube directly into cleaning solution and apply to surface at low pressure (for best results, limit your work area to sections approximately 6 feet square and always apply detergent from bottom to top). Allow detergent to remain on surface 1-3 minutes. Do not allow detergent to dry on surface. If surface appears to be drying, simply wet down surface with fresh water. If needed, use brush to remove stubborn dirt. Rinse at high pressure from top to bottom in an even sweeping motion keeping the spray nozzle approximately 1 foot from cleaning surface. Use overlapping strokes as you clean and rinse any surface. For best surface cleaning action spray at a slight angle.

Recommendations:

- Before cleaning any surface, an inconspicuous area should be cleaned to test spray pattern and distance for maximum cleaning results.
- If painted surfaces are peeling or chipping, use extreme caution as pressure washer may remove the loose paint from the surface.
- Keep the spray nozzle a safe distance from the surface you plan to clean. High pressure wash a small area, then check the surface for damage. If no damage is found, continue to pressure washing.

CAUTION - Never use:

- Bleach, chlorine products and other corrosive chemicals
- Liquids containing solvents (i.e., paint thinner, gasoline, oils)
- Tri-sodium phosphate products
- Ammonia products
- Acid-based products

These chemicals will harm the machine and will damage the surface being cleaned.

RINSING

It will take a few seconds for the detergent to clear. Apply safety latch to spray gun. Remove black soap nozzle from the quick coupler. Select and install the desired high pressure nozzle. **NOTE:** You can also stop detergent from flowing by simply removing detergent siphon tube from bottle.

SHUTTING DOWN AND CLEAN-UP

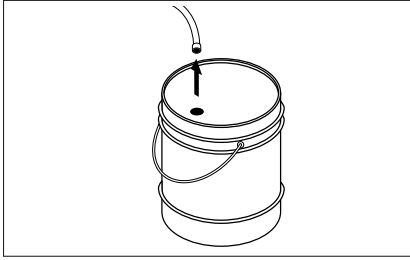

STEP 1: Remove detergent suction tube from container and insert into one gallon of fresh water. Slide nozzle forward for low pressure or to connect black detergent nozzle. Pull trigger on spray gun and siphon water for one minute.

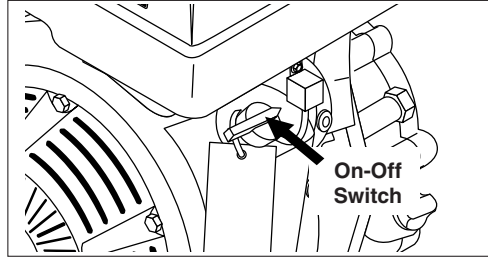

STEP 2: Turn off the engine.

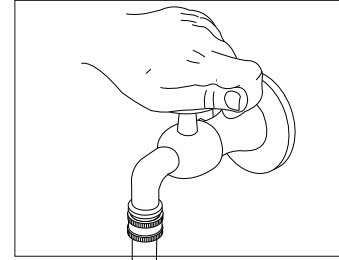

STEP 3: Turn off water supply.

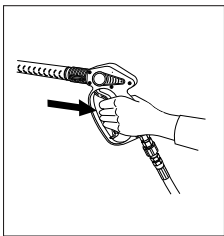

STEP 4: Press trigger to release water pressure.

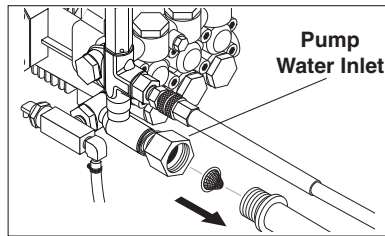

STEP 5: Disconnect the garden hose from the water inlet on the machine.

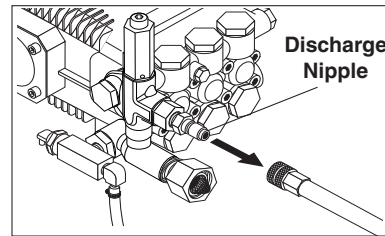

STEP 6: Disconnect the high pressure hose from discharge nipple.

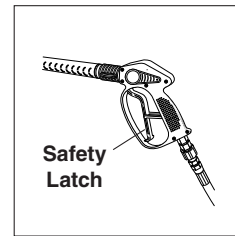

STEP 7: Engage the spray gun safety lock.

STORAGE

CAUTION: Always store your pressure washer in a location where the temperature will not fall below 32°F (0°C). The pump in this machine is susceptible to permanent damage if frozen. **FREEZE DAMAGE IS NOT COVERED BY WARRANTY.**

1. Stop the pressure washer, squeeze spray gun trigger to release pressure.
2. Detach water supply hose and high pressure hose.
3. Turn on the machine for a few seconds, until remaining water exits. Turn engine off immediately.
4. Drain the gas and oil from the engine.
5. Do not allow high pressure hose to become kinked.
6. Store the machine and accessories in a room which does not reach freezing temperatures.

CAUTION: Failure to follow the above directions will result in damage to your pressure washer.

When the pressure washer is not being operated or is being stored for more than one month, follow these instructions:

1. Replenish engine oil to upper level.
2. Drain gasoline from fuel tank, fuel line, fuel valve and carburetor.
3. Pour about one teaspoon of engine oil through the spark plug hole, pull the starter grip several

times and replace the plug. Then pull the starter grip slowly until you feel increased pressure which indicates the piston is on its compression stroke and leave it in that position. This closes both the intake and exhaust valves to prevent rusting of cylinder.

4. Cover pressure washer and store in a clean, dry place that is well ventilated away from open flame or sparks. **NOTE:** The use of a fuel additive, such as STA-BIL®, or an equivalent, will minimize the formulation of fuel deposits during shortage. Such additives may be added to the gasoline in the fuel tank of the engine, or to gasoline in a storage container.

After Extended Storage



CAUTION: Prior to restarting, thaw out any possible ice from pressure washer hoses, spray gun or wand.

Engine Maintenance

During the winter months, rare atmospheric conditions may develop which will cause an icing condition in the carburetor. If this develops, the engine may run rough, lose power and may stall. This temporary condition can be overcome by deflecting some of the hot air from the engine over the carburetor area. **NOTE:** Refer to the engine manufacturer's manual for service and maintenance of the engine.

TROUBLESHOOTING

PROBLEM	POSSIBLE CAUSE	SOLUTION
LOW OPERATING PRESSURE	Insufficient water supply. Closed faucet. Inlet hose kinked	Use larger garden hose; clean inlet water screen. Open faucet.
	Clogged inlet hose strainer	Check plumbing system for leaks. Retape leaks with teflon tape.
	Faulty or mis-adjusted unloader valve	Adjust unloader for proper pressure. Install repair kit when needed. Call local distributor.
	Worn packing in pump	Call Dealer Customer Support.
	Machine has been stored in freezing temperatures	Thaw out machine completely, including hose, spray gun and wand.
	Slow engine RPM	Call local distributor.
FLUCTUATING PRESSURE	Worn or dirty pump valves	Call local distributor.
	Nozzle is obstructed	Blow out or remove debris with fine needle.
	Pump sucking air, inlet hose leaking	Check that all hoses and fittings are airtight. Turn off machine and trigger spray gun until a steady flow of water emerges through the nozzle.
	Insufficient water supply	Turn water on full force. Check garden hose for kinks, leaks or blockage.
PRESSURE LOW AFTER PERIOD OF NORMAL USE	Nozzle worn	Replace nozzle.
	Unloader valve worn	Replace unloader valve (All models except 232336).
ENGINE WILL NOT START OR STOPS WHILE OPERATING	Low oil shutdown	Fill engine with oil.
	Out of gas	Fill fuel tank.
	Water in gasoline	Drain gas tank; fill with clean fuel.
ENGINE IS OVERLOADED	Nozzle partially blocked	Clean nozzle.
	Excessive pressure from high engine RPM	Adjust engine throttle to lower RPM.
WATER OR OIL LEAKING FROM BOTTOM OF PUMP	A small amount of leaking is normal	If excessive leaking occurs, Call local distributor.
PRESENCE OF WATER IN PUMP OIL (All models except 232336).	Water sprayed at machine	Change oil. Direct spray away from machine.
	High humidity in air	Check and change oil twice as often.
	Piston packing worn. Oil seal worn.	Call local distributor.

TROUBLESHOOTING

PROBLEM	POSSIBLE CAUSE	SOLUTION
ENGINE OPERATES FOR 15 MINUTES, THEN STOPS	Not enough gas or engine oil	Fill tank with gas. Check oil level.
	Vapor lock developed by heat of day	Keep gas tank full to avoid vapor locking.
	Obstruction in fuel filter	Clean or replace fuel filter.
ENGINE LACKS POWER	Dirty air filter	Replace air filter.
ENGINE FALTERS	Choke is opened too soon	Move choke to halfway position until engine runs smoothly.
WATER DRIPPING FROM UNDER PUMP (All models except 232336).	Piston packing worn	Call local distributor.
	O-Ring plunger retainer worn	Call local distributor.
	Cracked piston	Call local distributor.
OIL DRIPPING (All models except 232336).	Oil seal worn or damaged	Call local distributor.
WATER LEAKING FROM PUMP PROTECTOR	Spray gun closed with machine running 5 minutes or longer	Open spray gun or turn off machine.
	Excess water supply pressure	Place a pressure regulator at end of 50' garden hose.
NO DETERGENT	Detergent suction tube not properly connected to machine	Check connection.
	Detergent is too thick	Dilute detergent. For best results, use manufacturers detergent.
	Detergent filter valve is at lowest setting	Set detergent filter valve to a higher setting.
	Filter on detergent suction tube is clogged	Run warm water through filter to remove debris.
	Damaged or clogged detergent suction tube	Remove obstruction or replace detergent suction tube.
	A high pressure nozzle is attached.	Replace with black detergent nozzle.
	Discharge nozzle is obstructed	Blow out or remove debris with fine needle.
GARDEN HOSE CONNECTION LEAKS	Loose fittings	Tighten fittings.
	Missing/worn rubber washer	Insert new washer.
SPRAY WAND LEAKS	Spray wand not properly attached	Slide the spray wand into the gun. Turn the wand collar clockwise onto the spray gun threads until tight.
	Broken o-ring	Call local distributor and order an o-ring.
PUMP IS NOISY	Pump is sucking air	Check that hoses and fittings are air tight. Turn off machine and purge pump by squeezing trigger gun until a steady flow of water emerges through nozzle.

PREVENTATIVE MAINTENANCE

This pressure washer was produced with the best available materials and quality craftsmanship. However, you as the owner have certain responsibilities for the correct care of the equipment. Attention to regular preventative maintenance procedures will assist in preserving the performance of your equipment. Contact your dealer for maintenance. Regular preventative maintenance will add many hours to the life of your pressure washer. Perform maintenance more often under severe conditions. Check pump oil and engine oil level before first use of your new pressure washer.

MAINTENANCE SCHEDULE		
Engine Oil	Inspect	Daily
	Change	First month or 20 hours. Every 100 hours or every 6 months after first month
	Filter	Every 50 hours
Air Cleaner/Filter	Inspect	Every 50 hours
	Clean	Monthly
Engine Fuel Filter		500 hours or 6 months
Spark Plug Maintenance		300 hours or annually
Clean Fuel Tank(s)		Annually
Replace Fuel Lines		Annually
Pump Oil (All models except 232336)	Inspect	Oil level daily
	Change	After first 50 hours, then every 500 hours or annually
Replace High Pressure Nozzle		Every 6 months
Replace Quick Connects/O-Rings		Annually/As needed
Clean Water Screen/Filter		Weekly
Replace HP Hose		Annually (if there are any signs of wear

OIL CHANGE RECORD

Check pump oil (all models except 232336) and engine oil level before first use of your new pressure washer.

Date Oil Changed Month/Day/Year	Estimated Operating Hours Since Last Oil Change	Date Oil Changed Month/Day/Year	Estimated Operating Hours Since Last Oil Change



**HOTSY LIMITED NEW PRODUCT WARRANTY
PRESSURE WASHERS
WHAT THIS WARRANTY COVERS**

All Hotsy pressure washers are warranted by Hotsy to the original purchaser to be free from defects in materials and workmanship under normal use, for the periods specified below. This Limited Warranty is subject to the exclusions shown below, is calculated from the date of the original purchase, and applies to the original components only. Any parts replaced under this warranty will assume the remainder of the part's warranty period.

SEVEN YEAR PARTS AND ONE YEAR LABOR WARRANTY:

Components manufactured by Hotsy, such as frames, handles, top and bottom wraps, float tanks, fuel tanks, belt guards, and internal components on the oil-end of HOTSY manufactured pumps. General, AR, Liberty, Comet and swash and wobble plate pumps have a one year warranty. Heating coils have a five year warranty from date of original machine purchase.

ONE YEAR PARTS AND ONE YEAR LABOR WARRANTY:

All other components, excluding normal wear items as described below, will be warranted for one year on parts and labor. Parts and labor warranty on these parts will be for one year regardless of the duration of the original component manufacturer's part warranty.

WARRANTY PROVIDED BY OTHER MANUFACTURERS:

Motors, generators, and engines, which are warranted by their respective manufacturers, are serviced through these manufacturers' local authorized service centers. Hotsy is not authorized and has no responsibility to provide warranty service for such components.

WHAT THIS WARRANTY DOES NOT COVER

This warranty does not cover the following items:

1. Normal wear items, such as nozzles, spray guns, discharge hoses, wands, quick couplers, seals, filters, gaskets, O-rings, packings, pistons, pump valve assemblies, strainers, belts, brushes, relief valves, fuses, pump protectors.
2. Damage or malfunctions resulting from accidents, abuse, modifications, alterations, incorrect installation, improper servicing, failure to follow manufacturer's maintenance instructions, or use of the equipment beyond its stated usage specifications as contained in the operator's manual.
3. Damage due to freezing, chemical deterioration, scale build up, rust, corrosion, or thermal expansion.
4. Damage to components from fluctuations in electrical or water supply.
5. Normal maintenance service, including adjustments, fuel system cleaning, and clearing of obstructions.
6. Transportation to service center, field labor charges, or freight damage.

WHAT YOU MUST DO TO OBTAIN WARRANTY SERVICE

In order to obtain warranty service on items warranted by Hotsy, you must return the product to your Authorized Hotsy Distributor, freight prepaid, with proof of purchase, within the applicable warranty period. If the product is permanently installed, you must notify your Authorized Hotsy Distributor of the defect. Your Authorized Hotsy Distributor will file a claim with Hotsy, who must subsequently verify the defect. In most cases, the part must be returned to Hotsy freight prepaid with the claim. For warranty service on components warranted by other manufacturer's, your Authorized Hotsy Distributor can help you obtain warranty service through these manufacturers' local authorized service centers.

LIMITATION OF LIABILITY

Hotsy's liability for special, incidental, or consequential damages is expressly disclaimed. In no event shall Hotsy's liability exceed the purchase price of the product in question. Hotsy makes every effort to ensure that all illustrations and specifications are correct, however, these do not imply a warranty that the product is merchantable or fit for a particular purpose, or that the product will actually conform to the illustrations and specifications. Our obligation under this warranty is expressly limited at our option to the replacement or repair at a service facility or factory designated by us, of such part or parts as inspection shall disclose to have been defective. **THE WARRANTY CONTAINED HEREIN IS IN LIEU OF ALL OTHER WARRANTIES, EXPRESS OR IMPLIED, INCLUDING ANY IMPLIED WARRANTY OF MERCHANTABILITY OR FITNESS FOR A PARTICULAR PURPOSE ARE EXPRESSLY LIMITED TO THE DURATION OF THIS WRITTEN WARRANTY.** Hotsy does not authorize any other party, including authorized Hotsy Distributors, to make any representation or promise on behalf of Hotsy, or to modify the terms, conditions, or limitations in any way. It is the buyer's responsibility to ensure that the installation and use of Hotsy products conforms to local codes. While Hotsy attempts to assure that its products meet national codes, it cannot be responsible for how the customer chooses to use or install the product. Some states do not allow limitations on how long an implied warranty lasts or the exclusion or limitation of incidental or consequential damages, so the above limitation or exclusion may not apply to you. This warranty gives you specific legal rights and you may also have other rights which vary from state to state.

HOTSY
www.hotsy.com

If you are looking for replacement parts for your Hotsy, please contact your local dealer. You can find a dealer by calling Hotsy at 800-525-1976 or by visiting www.hotsy.com.

